

Godox

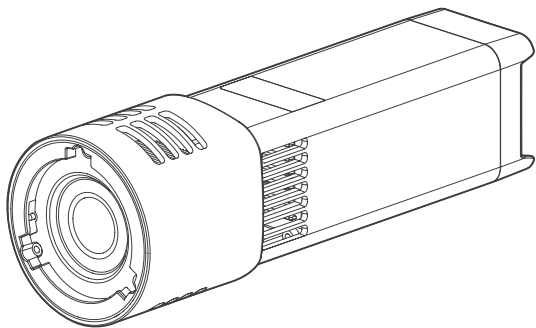

# RS100R

神牛全彩 LED 摄影灯  
Godox Full color LED Video Light

使用手册  
Instruction Manual

## 重要安全须知与注意事项

Godox 品牌 LED 摄影灯为专业设备，仅限具备资质的技术人员操作。使用前请务必完整阅读并理解产品说明书，严格遵循安全操作指南。未按规范操作可能导致以下风险：人身伤亡、设备损坏或财产损失。

### 危险

- 本产品为摄影灯具，禁止儿童使用。当儿童靠近时，家长或陪护人必须密切监督，以免儿童因碰撞灯具或私用灯具造成人身伤害。
- 本产品并非普通照明灯具，不可用于普通照明，任何有过眼部损伤或眼部敏感的人群均应避免使用本灯具。灯具点亮时，任何情况下均禁止直视灯珠，应该在专业灯光师指导下使用强光，任何情况下避免长时间处于强光环境，如引起眼睛不适，请及时关闭灯具，暂停使用，及时就医。
- 灯具点亮时，必须小心使用，禁止接触高温部件，如 LED 灯珠，避免造成灼伤。
- 禁止使用损坏的产品。产品在使用过程中，因跌落、受到挤压或遭受强烈冲击而造成外壳破裂，请勿继续使用，以免因接触到内部电子元件而受到电击伤害。
- 为避免火灾、电击或人身伤害危险，请仅使用生产商推荐的附件。
- 请勿私自拆卸产品，如产品出现故障，须由本公司或授权的维修人员进行检查维修。如灯珠损坏或因热变形，应停止使用，并及时联系制造商、服务代理商维修灯珠，以免发生意外。
- 请勿在易爆环境中（酒精、汽油等易燃挥发性溶剂或甲烷、乙烷等气体附近）使用和存放本产品。
- 产品在运行期间和运行后，灯头与用户、其他人员、热敏和可燃材料之间的距离必须随时保持至少 1 米以上。
- 本设备没有防水性能，请让设备保持干燥，请勿将本设备浸入水中或其他液体中。设备需安装在干燥且通风处，避免在雨天、潮湿、多尘或过热环境下使用。请勿将任何物体置于灯具上或使液体流入灯具内部，以免发生意外。

### 警告

- 不能阻挡、覆盖产品散热口。
- 使用后，产品完全冷切后才能包装。
- 如果电池更换不当会有爆炸危险，只能用同样类型或等效类型的电池来更换，仅维修人员可更换，非一般人员更换。请勿拆卸产品或拆解电池。
- 电池不得暴露在诸如日照，火烤或类似过热环境中，产品不得淋雨、进水。
- 消费者若使用电源适配器充电，则应购买配套使用获得 CCC 认证并满足标准要求的电源适配器。

- 电池禁止拆解、撞击、挤压或投入火中。若出现严重鼓胀，请勿继续使用。请勿置于高温环境中。浸水后禁止使用。
- 使用时，应放置在易散热的地方，不要放置在床头、被褥上、包裹里或其他不易散热的环境中使用，避免婴幼儿接触玩耍，儿童请在成人指导下使用。

### 小心

- 使用产品前，必须拆除所有运输包装材料和保护装置；
- 不使用产品时，请及时关机和停止供电；
- 安全说明依据本厂严格测试制定，产品设计和规格如有变更，恕不另行通知。客户可以登录神牛官网查看最新的电子版说明，了解产品最新资讯。

### 请勿直视光源

本设备包含型号核准代码为：CMIIT ID: 24J44V807298，为该产品的无线电发射模块。

## 部件名称

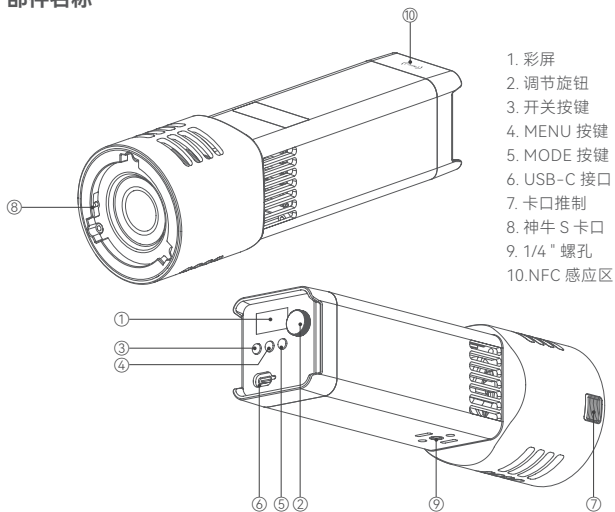

## RS100R 物品清单

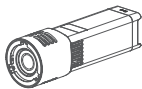

灯体 ×1



支架 AD-E2 ×1



USB-C 充电线 ×1



透镜反光杯 ×1



收纳袋 ×1



说明书 ×1

## RS100R 1K 物品清单

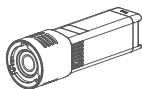

灯体 ×1



支架 AD-E2 ×1



USB-C 充电线 ×1



透镜反光杯 ×1

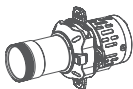

投影筒 SP36K ×1



收纳包 ×1



说明书 ×1

温馨提示：说明书中线图均为示意图，仅供参考。由于产品不断更新与升级，产品实物与线图可能存在差异，请以实物为准。

## 安装 / 拆卸透镜反光杯

1. 将透镜反光杯对准灯头卡口插入，顺时针旋转安装。

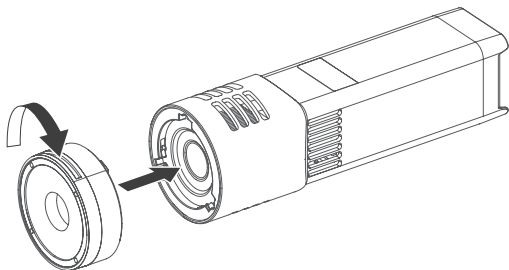

2. 如需拆卸, 按住卡口推制的同时逆时针旋转透镜反光杯即可。

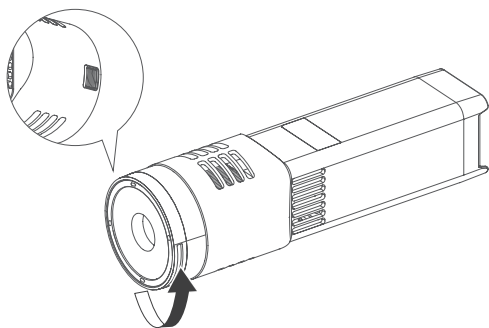

## 有线 DMX 连接

另购 DMX 转接线 DMX-C2, 插入 USB-C 接口后即具备 DMX 输出和输入, 再另购 DMX 连接线连接控制台。

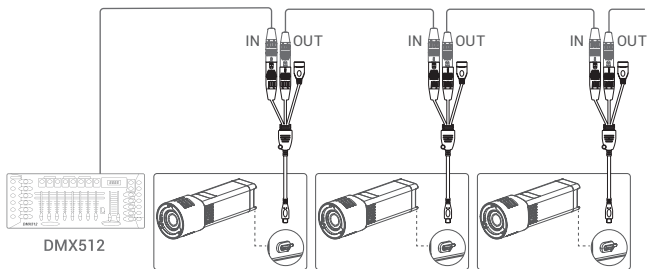

注: 仅展示连接 DMX512 控制台方式, 控制台、连接线、转接线 DMX-C2 需另购。

## 充电说明

使用 USB-C 充电线接通电源后，插入 USB-C 接口即可；低电量时请及时充满电再使用或放置。

## 开机 / 关机

长按开关按键实现开机，再次长按实现关机；可在菜单中设置防误触，调整开机方式。

## 模式选择

短按 MODE 按键进入模式选择，旋转调节旋钮可选图中任意一种模式，短按调节旋钮进入该模式的具体设置。通过短按并旋转调节旋钮设置参数值，顺时针旋转递增参数值，逆时针旋转递减参数值，设置完毕短按 MODE 按键返回上一级。



## CCT 模式

短按 MODE 按键进入模式选择，选中 CCT 后短按调节旋钮进入该模式。

亮度范围：0.0% ~ 100.0%

色温范围：1800K ~ 10000K

GM 范围：-100% ~ +100%



## HSI 模式

短按 MODE 按键进入模式选择，选中 HSI 后短按调节旋钮进入该模式。

亮度范围：0.0% ~ 100.0%

色相范围：0° ~ 360°

饱和度范围：0% ~ 100%



## GEL 模式

短按 MODE 按键进入模式选择, 选中 GEL 后短按调节旋钮进入该模式。

亮度范围: 0.0% ~ 100.0%

色温: 3200K 或 5600K

色片类型: R-GEL/L-GEL

R-GEL 色片组: COR./CAL./SPC./CINE.

L-GEL 色片组: COR./COLOR./600/COS./700

色相范围:  $-10^{\circ}$  ~  $10^{\circ}$

饱和度范围: -20% ~ 20%



## RGBW 模式

短按 MODE 按键进入模式选择, 选中 RGBW 后短按调节旋钮进入该模式。

亮度范围: 0.0% ~ 100.0%

红色范围: 0.0% ~ 100.0%

绿色范围: 0.0% ~ 100.0%

蓝色范围: 0.0% ~ 100.0%

白色范围: 0.0% ~ 100.0%



## X-Y 模式

短按 MODE 按键进入模式选择, 选中 X-Y 后短按调节旋钮进入该模式。

亮度范围: 0.0% ~ 100.0%

X 坐标: 0.0000 ~ 0.8500

Y 坐标: 0.0000 ~ 0.8500



## FX 模式

短按 MODE 按键进入模式选择, 选中 FX 后短按调节旋钮进入该模式, 通过旋转调节旋钮可选 14 类光效, 短按调节旋钮进入某一类光效的具体设置。

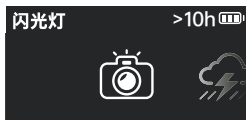

光效	亮度	类型	色温 / 色相	速度	其他
闪光灯	0.0% - 100.0%	CCT/HSI	1800K-10000K/ 0-360°	1-100	模式: 闪光灯 / 镁光灯 触发: 自动 / 手动
雷闪电		×	1800K-10000K	×	闪烁次数: 随机 / 1-10 频率: 随机 / 2-20 触发: 自动 / 手动
多云		×	×	随机 / 1-100	亮暗比例: 30%-90%
坏灯泡		CCT/HSI	1800K-10000K/ 0-360°	1-100	×
电视机		CCT/HSI	×	1-100	×
蜡烛		×	×	1-100	×
火		×	×	1-100	×
烟花		×	×	1-100	余烬: 1-100
爆炸		CCT/HSI	1800K-10000K/ 0-360°	1-100	余烬: 1-100 触发: 自动 / 手动
焊接		CCT/HSI	1800K-10000K/ 0-360°	1-100	×
警车		红 + 蓝、红 + 黄 + 蓝、红 + 白 + 蓝、黄、蓝 + 黄、蓝 + 白、蓝、红	×	×	模式: 1-5
SOS		CCT/HSI	1800K-10000K/ 0-360°	×	×
彩光循环		×	×	1-100	饱和度: 0%-100%
派对	×	×	1-100	饱和度: 0%-100%	

注: 根据需求旋转调节旋钮设置当前参数值, 设置完毕后短按并旋转调节旋钮可跳入下一栏参数进行设置; 选中手动时, 通过短按一次调节旋钮触发一次该光效; 某个光效设置完毕后短按 MODE 按键返回上一级。

## 菜单设置

短按 MENU 按键进入菜单界面，旋转并短按调节旋钮可进入以下任意一项的设置，设置完毕短按 MENU 按键返回上一级。

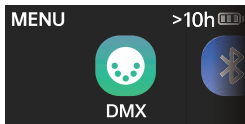

## DMX

短按调节旋钮进入 DMX，通过短按并旋转调节旋钮设置参数值，如下表所示。

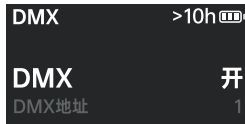

一级选项	二级选项	说明
地址	001-512	起始地址
DMX 模式	01: CCT 8 Bit	8 位 CCT 模式
	02: HSI 8 Bit	8 位 HSI 模式
	03: RGB 8 Bit	8 位 RGB 模式
	04: RGBW 8 Bit	8 位 RGBW 模式
	05: X-Y 8 Bit	8 位 X-Y 模式
	06: CCT+HSI 8 Bit	8 位 CCT+HSI 模式
	07: CCT+RGBW 8 Bit	8 位 CCT+RGBW 模式
	08: FX 8 Bit	8 位 FX 模式
	09: GEL 8 Bit	8 位 GEL 模式
	10: CCT 16 Bit	16 位 CCT 模式
	11: HSI 16 Bit	16 位 HSI 模式
	12: RGB 16 Bit	16 位 RGB 模式
	13: RGBW 16 Bit	16 位 RGBW 模式
	14: X-Y 16 Bit	16 位 X-Y 模式
	15: FX 16 Bit	16 位 FX 模式
	16: GEL 16 Bit	16 位 GEL 模式
	17: ULTIMATE 8 Bit	8 位 ULTIMATE 模式
	18: ULTIMATE 16 Bit	16 位 ULTIMATE 模式

RDM 状态	开启	开启 RDM, 开启后控制台可设置灯具地址及 DMX 模式
	关闭	关闭 RDM
DMX 丢失状态	保持最后状态	失去 DMX 控制信号后, 在关机或再次接收有效 DMX 控制信号前, 持续使用最后一次接收的 DMX 控制信号。
	直接关闭	灯具直接熄灭
	保持最后状态 2 分钟熄灭	失去 DMX 控制信号后, 持续使用最后一次接收的 DMX 控制信号 2 分钟, 2 分钟后灯具熄灭。注: 如 2 分钟内接收到有效 DMX 控制信号, 则使用新的 DMX 控制信号。
终止开关	开启	开启 DMX 终端
	关闭	关闭 DMX 终端
增强通道	开启	开启增强通道信号
	关闭	关闭增强通道信号
DMX 通道表	(扫描二维码查看)	

注: 使用 DMX/RDM 控制台控制灯具, 可登录官网 <https://www.godox.com.cn/> 下载 DMX 模式表。

## 蓝牙

短按调节旋钮进入蓝牙, 通过短按并旋转调节旋钮设置开启或关闭; 如需蓝牙重置, 旋转调节旋钮到重置栏, 短按调节旋钮选择确定或取消; 下方查看蓝牙 MAC 码, 方便查找灯具。

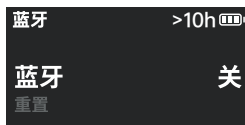

## “Godox Light”app 下载

扫描二维码即可下载“Godox Light”手机 app  
(安卓和苹果系统都可以使用)。

注:

1. 首个移动设备(手机或平板电脑)可直接使用 app 操控灯体。更换其他移动设备时, 灯体需进行蓝牙重置方可正常使用 app。
2. app 需升级至 V3.0 以上版本。



## 调光曲线

短按调节旋钮进入调光曲线, 通过旋转调节旋钮可选线性 / S 曲线 / 指数 / 对数, 选定后短按调节旋钮完成设置。

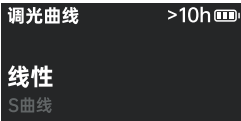

## 平滑度

短按调节旋钮进入平滑度, 通过旋转调节旋钮可选默认 / 平滑 / 平滑关, 选定后短按调节旋钮完成设置。

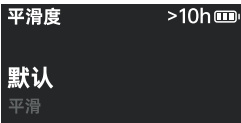

平滑度	备注
默认	亮度数据进行基础平滑处理, 实现平滑调光, 缩短响应时间
平滑度	亮度数据进行平滑处理, 实现超平滑调光, 响应时间慢
关闭	未对亮度数据进行平滑处理, 响应时间最快

## 色域

短按调节旋钮进入色域，通过短按并旋转调节旋钮可选原始色域 / 校色色域 / Rec.709 / DCI-P3，选定后短按调节旋钮完成设置。

色域

>10h 

原始色域

校色色域

## 风扇

短按调节旋钮进入风扇，通过旋转调节旋钮可选静音 / 自动 / 低速 / 中速 / 高速，选定后短按调节旋钮完成设置。

风扇

>10h 

静音

自动

## 防误触

短按调节旋钮进入防误触，通过旋转调节旋钮可选关闭或开启，选定后短按调节旋钮完成设置。

关闭：长按开关按键进入主界面。

开启：长按开关按键后旋转调节旋钮进入主界面。

防误触

>10h 

关闭

开启

## 屏幕设置

短按调节旋钮进入屏幕设置，通过旋转调节旋钮设置屏幕亮度值，逆时针旋转递减亮度，顺时针旋转递增亮度，范围：10%-100%。

屏幕设置

>10h 



80%

## 语言

短按调节旋钮进入语言，通过旋转调节旋钮可选简体中文 /English，选定后短按调节旋钮完成设置。

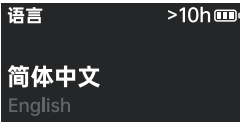

## 版本与升级

短按调节旋钮进入版本与升级，此界面可查看升级提示。



## “Godox Light”app 固件升级

手机中打开 Godox Light，进入其中一个场景，点击 + (添加设备)，设备添加完成后，点击：延伸出多项设置，再选择固件升级即可。

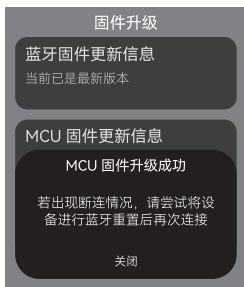

## 恢复出厂设置

短按调节旋钮进入恢复出厂设置，通过旋转调节旋钮可选确定 / 取消；短按调节旋钮确定恢复出厂，灯具自动重启，界面出现简体中文和 English 选项，设置需要的语言后灯体亮度值自动变为 100%。

恢复出厂设置 >10h 

确定

取消

## 灯具信息

短按调节旋钮进入灯具信息，此界面可查看当前灯具的基础信息。

## NFC 加灯

1. 开启手机与灯具的蓝牙功能，确保“Godox Light”app 版本在 V3.2.4 以上。
2. 打开 app 进入对应场景，点击 + 选择“NFC 加灯”，手机靠近灯具 NFC 感应区即可完成加灯。

## 照度数据

色温	测试条件	照度单位	1m	2m	3m
1800K	裸灯	lux	1530	382	173
		fc	142	36	16
	搭配透镜反光杯	lux	8510	1890	841
		fc	791	176	78
2800K	裸灯	lux	3320	832	381
		fc	309	77	35
	搭配透镜反光杯	lux	18100	4660	2030
		fc	1682	433	189
3200K	裸灯	lux	3270	823	377
		fc	304	76	35
	搭配透镜反光杯	lux	17900	4540	2010
		fc	1664	422	187
4300K	裸灯	lux	3080	775	355
		fc	286	72	33
	搭配透镜反光杯	lux	17000	4330	1910
		fc	1580	402	178
5600K	裸灯	lux	2860	718	329
		fc	266	67	31
	搭配透镜反光杯	lux	15900	4050	1790
		fc	1478	376	166
6500K	裸灯	lux	2740	688	316
		fc	255	64	29
	搭配透镜反光杯	lux	15300	3900	1730
		fc	1422	362	161
8500K	裸灯	lux	2550	640	294
		fc	237	59	27
	搭配透镜反光杯	lux	14500	3660	1630
		fc	1348	340	151

色温	测试条件	照度单位	1m	2m	3m
10000K	裸灯	lux	2450	615	283
		fc	228	57	26
	搭配透镜反光杯	lux	14000	3540	1570
		fc	1301	329	146
R(红光)	裸灯	lux	670	171	76
		fc	62	16	7
	搭配透镜反光杯	lux	3880	949	409
		fc	361	88	38
G(绿光)	裸灯	lux	1490	375	172
		fc	138	35	16
	搭配透镜反光杯	lux	8830	2200	980
		fc	821	204	91
B(蓝光)	裸灯	lux	473	118	55
		fc	44	11	5
	搭配透镜反光杯	lux	3260	859	382
		fc	303	80	36

以上数据均为平均值, 非绝对值, 以上测试皆在灯体 100%亮度下进行。

## 规格参数

型号	RS100R
USB-C 接口	输入: 28V = 5A
色温范围	1800K ~ 10000K
GM 范围	-100% ~ 100%
调光范围	0.0% ~ 100.0%
调光曲线	线性 / S 曲线 / 指数 / 对数
FX 光效	14 类
CRI	≈ 95
TLCI	≈ 95
控制方式	有线 DMX/RDM, 蓝牙, 灯体控制
蓝牙控制距离	30m
工作环境温度	-10°C ~ 40°C
尺寸 (不含透镜反光杯) ≈	234mm*78mm*78mm
净重 (不含透镜反光杯) ≈	921g

规格和参数如有变更, 恕不另行通知。

## Important Safety Instructions and Precautions

Godox LED lights are professional equipment and should only be operated by professionals. Carefully read and fully understand the instruction manual before use and strictly follow the safety instructions. Failure to do so may result in death, serious injury, damage to the product, or other property damage.

### **Danger**

- Professional lighting fixture is prohibited for children. When children are near, parents or guardians must supervise closely to prevent them from personal injury due to collision with light or private use of light.
- This product is not ordinary lighting fixture and cannot be used for general lighting. Anyone who has suffered eye damage or has sensitive eyes should avoid using this product. When the light is on, it is forbidden to look directly at the lamp beads under any circumstances. Strong light should be used under the guidance of professional lighting engineers. Avoid prolonged exposure to strong light under any circumstances. If it causes eye discomfort, turn off the light, suspend use and seek medical attention promptly.
- When the light is on, it must be used with care. Do not touch high-temperature parts, such as LED lamp beads, to avoid burns.
- Do not use damaged product. Stop using immediately if the product shell is cracked due to falling, squeezing, or strong impact, to avoid touching the internal electronic components and getting an electric shock.
- Please use only the accessories recommended by our factory to avoid fire, electric shock or personal injury.
- Do not disassemble the product without permission. If the product malfunctions, it must be checked and repaired by authorized maintenance personnel. If the lamp bead is damaged or deformed by heat, stop using it, and contact the manufacturer, service agent or qualified maintenance personnel to replace the lamp bead in time to avoid accidents.
- Do not use and store this product in explosive atmospheres (near flammable volatile solvents such as alcohol, gasoline, or gases such as methane and ethane).
- Maintain at least 1 meter distance between the light head and the user, other people, and heat-sensitive or flammable items during and after operation of the product.
- This equipment is not waterproof, please keep it dry and do not immerse it in water or other liquids. The equipment should be installed in a dry and ventilated place, and avoid using it in rainy, humid, dusty or overheated environments. Do not place any objects on the lamp or let liquid flow into the lamp to avoid accidents.

## **Warning**

- Do not block or cover the heat dissipation port of the product.
- After use, the product should be completely cooled before packaging.
- Danger of explosion if the battery are not replaced properly, danger of fire or explosion if replaced with the wrong type of battery pack, replace only with battery of the same type or equivalent. Replace by service personnel only, not general personnel. Do not disassemble the product or disassemble the battery.
- The battery must not be exposed to conditions such as sunlight, fire, or similar excessive heat. Do not expose to rain or water.
- The Battery is not allowed to be disassembled, hit, crushed or thrown into fire. Do not continue to use if it is seriously inflated. Do not place in a high temperature environment. Do not use after immersion in water.
- When using, it should be placed in a place where it is easy to dissipate heat, and should not be placed on the bedside, bedding, in a package or other environments that are not easy to dissipate heat. Keep out of contact with infants and young children, and children should use under adult guidance.

## **Attention**

- All transport protective materials and packages on the product must be removed before use.
- When not in use, please turn off the product and stop the power supply promptly.
- The safety instructions are formulated according to the strict testing of the factory, and the design and specifications of the equipment are subject to change without prior notice. Customers can view the latest electronic instruction manuals on the official website of Godox and learn about the latest product information.



**Do not stare at the operating light source.**

## Names of Parts

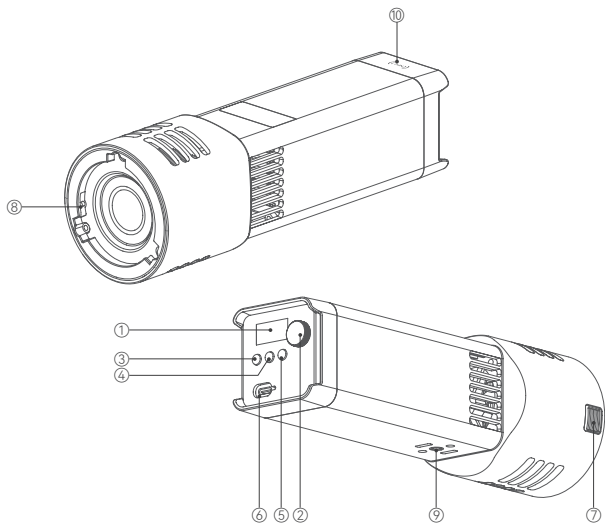

1. Color Screen
2. Select Dial
3. Power Switch Button
4. MENU Button
5. MODE Button

6. USB-C Port
7. Mount Locking Pusher
8. Godox S-mount
9. 1/4 " Screw Hole
10. NFC Sensing Area

## What's Inside RS100R

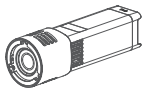

Light Body x1



Holder AD-E2 x1



USB-C Charging  
Cable x1



Lens Reflector  
x1



Storage Bag x1



Instruction Manual x1

## What's Inside RS100R 1K

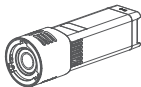

Light Body x1



Holder AD-E2 x1



USB-C Charging  
Cable x1



Lens Reflector  
x1

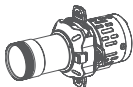

Projection SP36K x1



Storage Bag x1



Instruction Manual x1

Note: Due to continuous updates and upgrades of the products, there may be differences between the actual products and the pictures. Therefore, the pictures are for reference only, products to prevail in kind.

## Install/Disassemble the Lens Reflector

1. Align the lens reflector with the mount and rotate clockwise to install.

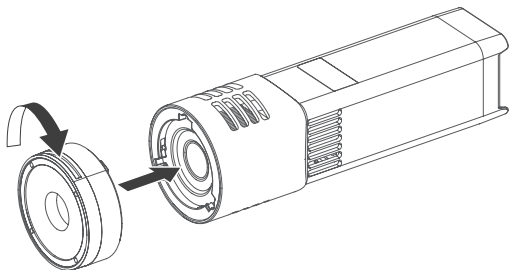

2. Press and hold the mount locking pusher and rotate counterclockwise to remove the lens reflector.

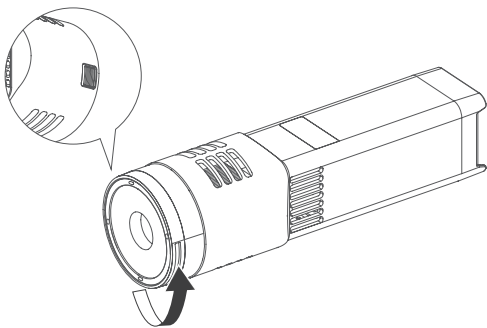

## Wired DMX Connection

After inserting a separately purchased DMX adapter cable DMX-C2 into the wired DMX port, the fixture is equipped with DMX output and input ports, wired DMX connection can be realized by connecting the separately purchased DMX cable to the console.

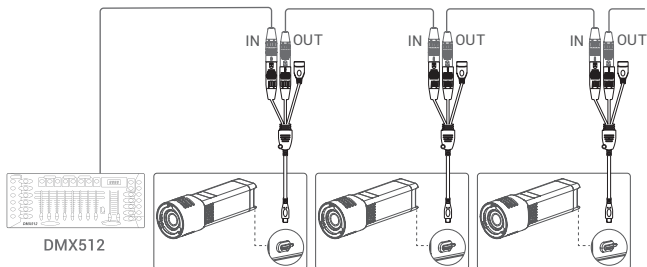

Note: The above pictures only show the method to connect the DMX512 controller, the controller, connection cable and are adapter cable DMX-C2 sold separately.

## Charging Instruction

Connect the USB-C port on the light body to the power source via the USB-C charging cable to charge it. When the battery is low, please fully charge it in time before using or placing it.

## Power Switch

Press and hold the power switch button to turn on or off the device. The bootup mode is available for adjustment in anti-false touch setting.

## Mode Selection

Short press the MODE button to enter selection interface, rotate the select dial to select the desired mode, then press it to enter the corresponding parameter settings. Rotate the select dial clockwise to increase the parameters, while rotate anticlockwise to decrease the parameters. Short press the MODE button to return to the previous interface.



## CCT Mode

Short press the MODE button to enter mode selection, rotate and press the select dial to select CCT mode, in which you can adjust the DIM/CCT/GM.

DIM range: 0.0% -100.0%

CCT range: 1800K~10000K

GM range: -100%~+100%



## HSI Mode

Short press the MODE button to enter mode selection, rotate and press the select dial to select HSI mode, in which you can adjust the DIM/HUE/SAT.

DIM range: 0.0% -100.0%

HUE range: 0°~360°

SAT range: 0%~100%



## GEL Mode

Short press the MODE button to enter mode selection, rotate and press the select dial to select GEL mode, in which you can adjust the following parameters.

DIM range: 0.0% -100.0%

CCT range: 3200K or 5600K

Gel type: R-GEL/L-GEL

R-GEL: COR./CAL./SPC./CINE.

L-GEL: COR./COLOR./600/COS./700

HUE range:  $-10^{\circ}$ ~ $10^{\circ}$

SAT range: -20% ~20%



## RGBW Mode

Short press the MODE button to enter mode selection, rotate and press the select dial to select RGBW mode, in which you can adjust the DIM/red/green/blue/white.

DIM range: 0.0% -100.0%

Red range: 0.0% -100.0%

Green range: 0.0% -100.0%

Blue range: 0.0% -100.0%

White range: 0.0% -100.0%



## X-Y Mode

Short press the MODE button to enter mode selection, rotate and press the select dial to select X-Y mode, in which you can adjust the DIM/X coordinate/Y coordinate.

DIM range: 0.0% -100.0%

X coordinate: 0.0000~0.8500

Y coordinate: 0.0000~0.8500



## FX Mode

Short press the MODE button to enter mode selection, rotate and press the select dial to select FX mode, in which you can choose among the following 14 effects and adjust their respective parameters.

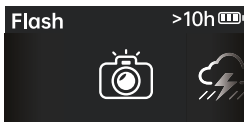

Effect	DIM	Color	CCT/HUE	Speed	Others
Flash	0.0% - 100.0%	CCT/HSI	1800K-10000K/ 0-360°	1-100	Mode: Camera Flash/ Flash Bulb Trigger: Auto/Manual
Lightning		×	1800K-10000K	×	Times: Random/1-10 Frequency: Random /2-20 Trigger: Auto/Manual
Cloudy		×	×	Random/1-100	Ratio: 30% -90%
Broken Bulb		CCT/HSI	1800K-10000K/ 0-360°	1-100	×
TV		CCT/HSI	×	1-100	×
Candle		×	×	1-100	×
Fire		×	×	1-100	×
Firework		×	×	1-100	Ember: 1-100
Explosion		CCT/HSI	1800K-10000K/ 0-360°	1-100	Ember: 1-100 Trigger: Auto/Manual
Welding		CCT/HSI	1800K-10000K/ 0-360°	1-100	×

Cop Car		Red+Blue, Red+Yellow+ Blue, Red+ White+Blue, Yellow, Blue +Yellow, Blue+White, Blue, Red	x	x	Mode: 1-5
SOS		CCT/HSI	1800K-10000K/ 0-360°	x	x
RGB Cycle	x	x	x	1-100	SAT: 0%-100%
Party	x	x	x	1-100	SAT: 0%-100%

Note: Please rotate the select dial to adjust the parameters, then press the and rotate the select dial to the next parameter. Select manual, the effect can be triggered once by pressing the select dial once. After a certain effect is set, press MODE button can return to the 14 effects interface.

## MENU Settings

Press the MENU button to enter menu interface, rotate and press the select dial to enter the following setting options, press the MENU button can return to the previous interface.

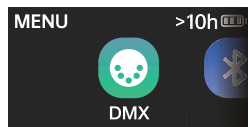

## DMX

Short press the select dial to enter DMX interface, press and rotate the select dial to adjust the following settings.

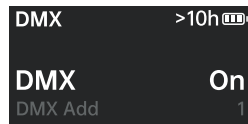

Level 1 Option	Level 2 Option	Level 2 Option
DMX Address	001-512	Initial address
DMX Mode	01: CCT 8 Bit	CCT mode in 8bit
	02: HSI 8 Bit	HSI mode in 8bit
	03: RGB 8 Bit	RGB mode in 8bit
	04: RGBW 8 Bit	RGBW mode in 8bit
	05: X-Y 8 Bit	X-Y mode in 8bit
	06: CCT+HSI 8 Bit	CCT+HSI mode in 8bit
	07: CCT+RGBW 8 Bit	CCT+RGBW mode in 8bit
	08: FX 8 Bit	FX mode in 8bit
	09: GEL 8 Bit	GEL mode in 8bit
	10: CCT 16 Bit	CCT mode in 16bit
	11: HSI 16 Bit	HSI mode in 16bit
	12: RGB 16 Bit	RGB mode in 16bit
	13: RGBW 16 Bit	RGBW mode in 16bit
	14: X-Y 16 Bit	X-Y mode in 16bit
	15: FX 16 Bit	FX mode in 16bit
	16: GEL 16 Bit	GEL mode in 16bit
	17: ULTIMATE 8 Bit	ULTIMATE mode in 8bit
	18: ULTIMATE 16 Bit	ULTIMATE mode in 16bit
RDM State	On	Turn on RDM, the controller can set the fixture address and DMX mode
	Off	Turn off RDM
DMX Lost	Hold Last Command	After the DMX control signal is lost, continue to use the last received DMX control signal until power down or a valid DMX control signal is received again.
	Black Out	The light is off immediately.
	Black Out After 2 min	After the DMX control signal is lost, continue to use the last received DMX control signal for 2 minutes then black out. Note: If a valid DMX control signal is received within 2 minutes, then use the new DMX control signal.

Termination	On	Turn on DMX terminal
	Off	Turn off DMX terminal
Extend DMX Channels	On	Turn on extend DMX channels
	Off	Turn off extend DMX channels
QR Code	Scan to check the DMX table	

Note: Please refer to the DMX mode specification to control the device by DMX/RDM. The electronic version can be downloaded from the official website <https://www.godox.com>.

## Bluetooth

Short press the select dial to enter Bluetooth interface, press and rotate the select dial to Bluetooth to turn it on or off. If you need to reset the Bluetooth, rotate the select dial to reset and press it. The MAC code is on the corner for quick check.

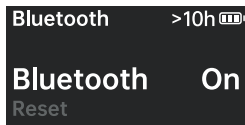

## "GODOX Light" app Downloading

Scan the QR code to download the "Godox Light" smartphone app (can be used in Android and iOS).

Note:

1. The app can be used directly on the firstly installed device (smartphone or tablet). When change to other mobile device (smartphone or tablet), the light shall be reset before the normal connection of the app.
2. The app should be version 3.0 or above.



## Curves

Short press the select dial to enter dimming curves interface, press and rotate the select dial to select among linear, S-curve, exponential and logarithmic.

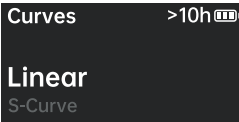

## Smoothing

Short press the select dial to enter smoothing interface, press and rotate the select dial to choose among default, smooth and off.

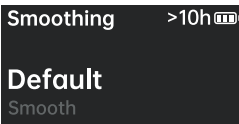

Smoothing	Note
Default	The brightness data is basically smoothed to achieve smooth dimming and shorten the response time.
Smooth	The brightness data is smoothed to achieve ultra-smooth dimming with a slow response time.
Off	No smoothing of brightness data, fastest response time.

## Color Space

Short press the select dial to enter color space interface, press and rotate the select dial to choose among original gamut, correction gamut, Rec.709 and DCI-P3.

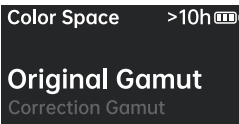

## Fan

Short press the select dial to enter fan interface, press and rotate the select dial to select among off, auto, medium and high.

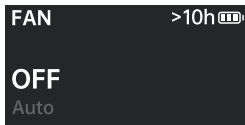

## Anti-False Touch

Short press the select dial to enter anti-false touch interface, press and rotate the select dial to select between off and on.

Off: Press and hold the power switch button to enter the main interface.

On: Press and hold the power switch button then rotate the select dial to enter the main interface.

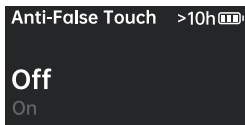

## Display

Short press the select dial to enter display interface, press and rotate the select dial to adjust the display brightness from 10% to 100%.

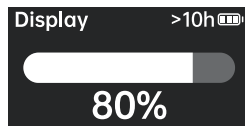

## Language

Short press the select dial to enter language interface, press and rotate the select dial to choose between simplified Chinese and English.

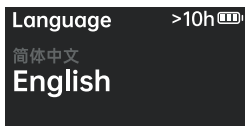

## Upgrade

Short press the select dial to enter upgrade interface to check the upgrade instruction.

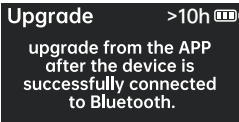

## "GODOX Light" app Firmware Upgrade

Open Godox Light, enter a certain scene and click "+" to add a fixture, then click : to display more settings, choose firmware upgrade.

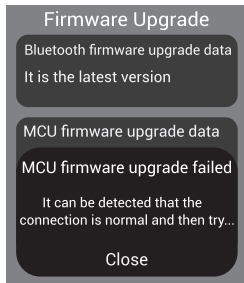

## Factory Reset

Short press the select dial to enter factory reset interface to choose yes or no. If you choose yes, the device will automatically reset and reboot, then simplified Chinese and English options show on the display for your choice, after which the brightness will turn to 100% automatically.

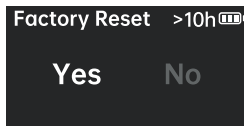

## Fixture Info

Short press the select dial to enter fixture info interface to check the product basic information.

## NFC Fixture Addition

1. Make sure the Bluetooth and NFC functions of smartphone and fixture are turned on, the **【Godox Lightt】** app is V3.2.4 or above.
2. Turn on the **【Godox Light】** app and enter the corresponding scene, click **【+】** to select **【NFC Addition】** function, bring the NFC sensing area of smartphone near the sensing area of fixture to scan to add.

## Illuminance Data

CCT	Testing Condition	Unit	1m	2m	3m
1800K	Bare Light	lux	1530	382	173
		fc	142	36	16
	With Lens Reflector	lux	8510	1890	841
		fc	791	176	78
2800K	Bare Light	lux	3320	832	381
		fc	309	77	35
	With Lens Reflector	lux	18100	4660	2030
		fc	1682	433	189
3200K	Bare Light	lux	3270	823	377
		fc	304	76	35
	With Lens Reflector	lux	17900	4540	2010
		fc	1664	422	187
4300K	Bare Light	lux	3080	775	355
		fc	286	72	33
	With Lens Reflector	lux	17000	4330	1910
		fc	1580	402	178
5600K	Bare Light	lux	2860	718	329
		fc	266	67	31
	With Lens Reflector	lux	15900	4050	1790
		fc	1478	376	166
6500K	Bare Light	lux	2740	688	316
		fc	255	64	29
	With Lens Reflector	lux	15300	3900	1730
		fc	1422	362	161
8500K	Bare Light	lux	2550	640	294
		fc	237	59	27
	With Lens Reflector	lux	14500	3660	1630
		fc	1348	340	151

CCT	Testing Condition	Unit	1m	2m	3m
10000K	Bare Light	lux	2450	615	283
		fc	228	57	26
	With Lens Reflector	lux	14000	3540	1570
		fc	1301	329	146
R(Red)	Bare Light	lux	670	171	76
		fc	62	16	7
	With Lens Reflector	lux	3880	949	409
		fc	361	88	38
G(Green)	Bare Light	lux	1490	375	172
		fc	138	35	16
	With Lens Reflector	lux	8830	2200	980
		fc	821	204	91
B(Blue)	Bare Light	lux	473	118	55
		fc	44	11	5
	With Lens Reflector	lux	3260	859	382
		fc	303	80	36

Note: All the data are average values instead of absolute values. All the above tests are based on the condition of 100% brightness.

## Technical Data

Model	RS100R
USB-C Port	Input: 28V $\overline{=}$ 5A
CCT Range	1800K ~ 10000K
GM Adjust	-100% ~ 100%
Brightness Range	0.0% ~ 100.0%
Dimming Curves	linear, S-curve, exponential, logarithmic
FX Modes	14
CRI	$\approx$ 95
TLCI	$\approx$ 95
Controlling Methods	Wired DMX/RDM, Bluetooth, light body control
Bluetooth Controlling Distance	30m
Working Environment Temperature	-10 $^{\circ}$ C ~ 40 $^{\circ}$ C
Dimension (without lens reflector) $\approx$	9.21*3.07*3.07"
Net Weight (without lens reflector) $\approx$	921g

Specifications and data may subject to changes without notice.

## **FCC Caution**

This device complies with part 15 of the FCC Rules. Operation is subject to the following two conditions:

- (1) This device may not cause harmful interference, and
- (2) this device must accept any interference received, including interference that may cause undesired operation.

Any Changes or modifications not expressly approved by the party responsible for compliance could void the user's authority to operate the equipment.

Note: This equipment has been tested and found to comply with the limits for a Class B digital device, pursuant to part 15 of the FCC Rules. These limits are designed to provide reasonable protection against harmful interference in a residential installation. This equipment generates uses and can radiate radio frequency energy and, if not installed and used in accordance with the instructions, may cause harmful interference to radio communications. However, there is no guarantee that interference will not occur in a particular installation. If this equipment does cause harmful interference to radio or television reception, which can be determined by turning the equipment off and on, the user is encouraged to try to correct the interference by one or more of the following measures:

- Reorient or relocate the receiving antenna.
- Increase the separation between the equipment and receiver.
- Connect the equipment into an outlet on a circuit different from that to which the receiver is connected.
- Consult the dealer or an experienced radio/TV technician for help.

The device has been evaluated to meet general RF exposure requirement. The device can be used in portable exposure condition without restriction. The use distance is not more than 5mm.

## **Warning**

Operating frequency: 2402MHz – 2480MHz(BT)

Maximum EIRP Power: 5dBm(BT)

## **Declaration of Conformity**

GODOX Photo Equipment Co.,Ltd. hereby declares that this equipment are in compliance with the essential requirements and other relevant provisions of Directive 2014/53/EU. In accordance with Article 10(2) and Article 10(10), this product is allowed to be used in all EU member states.For more information of DoC, Please click this web link:

<https://www.godox.com/eu-declaration-of-conformity/>

The device complies with RF specifications when the device used at 0mm from your body.

## IC Warning

This device complies with Innovation, Science and Economic Development Canada licence-exempt RSS standard(s). Operation is subject to the following two conditions:

- (1) This device may not cause interference, and
- (2) This device must accept any interference, including interference that may cause undesired operation of the device.

Cet appareil est conforme aux normes RSS exemptées de licence d'Innovation, Sciences et Développement économique Canada. L'exploitation est soumise aux deux conditions suivantes:

- (1) Cet appareil ne peut pas causer d'interférences, et
- (2) Cet appareil doit accepter toute interférence, y compris celles qui pourraient entraîner un fonctionnement accidentel de l'appareil.

Any Changes or modifications not expressly approved by the party responsible for compliance could void the user's authority to operate the equipment.

Tout changement ou modification non expressément approuvé par la partie responsable de la réglementation de l'OCDE peut faire perdre à l'utilisateur le droit d'utiliser l'appareil.

Note: This equipment has been tested and found to comply with the limits for a Class B digital device, pursuant to part 15 of the FCC Rules. These limits are designed to provide reasonable protection against harmful interference in a residential installation. This equipment generates uses and can radiate radio frequency energy and, if not installed and used in accordance with the instructions, may cause harmful interference to radio communications. However, there is no guarantee that interference will not occur in a particular installation. If this equipment does cause harmful interference to radio or television reception, which can be determined by turning the equipment off and on, the user is encouraged to try to correct the interference by one or more of the following measures:

- Reorient or relocate the receiving antenna.
- Increase the separation between the equipment and receiver.
- Connect the equipment into an outlet on a circuit different from that to which the receiver is connected.
- Consult the dealer or an experienced radio/TV technician for help.

Remarque: cet appareil a été testé pour répondre aux limites des appareils numériques de classe B conformément à la partie 15 des règles de la Federal Communications Commission des États - Unis. Ces limites sont conçues pour fournir une protection raisonnable contre les interférences nuisibles dans les installations résidentielles.

L'appareil génère de l'énergie RF utilisée et rayonne, ce qui peut causer des interférences nocives pour les communications radio s'il n'est pas installé et utilisé conformément aux instructions. Cependant, aucune Garantie contre les interférences dans une installation spécifique. Si l'appareil cause des interférences nuisibles à la réception de la radio ou de la télévision, qui peuvent être déterminées en éteignant et en allumant l'appareil, l'utilisateur est encouragé à tenter de corriger les interférences par une ou plusieurs des mesures suivantes:

- redirection ou repositionnement de l'antenne de réception.
- augmenter l'espacement entre l'appareil et le récepteur.
- Connecter l'appareil à une prise sur un circuit différent de celui auquel le récepteur est connecté.
- consultez votre revendeur ou un technicien radio / tv expérimenté pour obtenir de l'aide.

RF warning for Portable device:

The device has been evaluated to meet general RF exposure requirement. The device can be used in portable exposure condition without restriction.

Avertissement RF pour les appareils portables:

L'appareil a été évalué pour répondre aux exigences générales d'exposition aux radiofréquences.Équipement Peut être utilisé sans restriction dans des conditions d'exposition portables.

## 产品保修

尊敬的用户，本保修卡是申请保修服务的重要凭证，请您配合销售商填写并妥善保管，谢谢！

产品信息	型号	产品条码
用户信息	姓名	联系电话
	通信地址	
销售商信息	名称	
	联系电话	
	通信地址	
	销售日期	
备注		

注：此表应由销售商盖章确认。

### 产品信息

本文件适用于相关《产品保修信息》（见后面说明）所列产品，其他非属此范围的产品或部件（如促销品、赠品及其他出厂后附加的部件等）不在此保修承诺内。

### 保修期

产品及部件的相应保修期按相关的《产品保修信息》执行。保修期自产品首次购买日起算，购买日以购买产品时保修卡登记日期为准。

### 如何获得保修服务

您可直接与产品销售商或授权服务机构联系，也可拨打神牛产品售后服务电话，与我们联系，由我们的服务人员为您安排服务。申请保修时，您应提供有效的保修卡作为保修凭证，方可获得保修。如您不能提供有效的保修卡，则在我们确认产品或部件属于保修范围的情况下，也可以为您提供保修，但这不作为我们的义务。

## 不适用保修情况

如产品存在下列情况，本文件项下的保证和服务将不适用：①产品或部件超过相应保修期；②错误或不适当使用、维护或保管导致的故障或损坏，如：不当搬运；非按产品合理预期用途使用；不当插拔外接设备；跌落或外力挤压；接触或暴露于不适当温度、溶剂、酸碱、水浸或潮湿环境；③由非神牛授权机构或人员安装、修理、更改、添加或拆卸造成的故障或损坏；④产品或部件原有识别信息被修改变更或删除；⑤无有效保修卡；⑥使用非合法授权、非标准或非公开发行的软件造成的故障或损坏；⑦因不可抗力或意外事件造成的故障或损坏；⑧其他非因产品本身质量问题导致的故障或损坏。遇上述情况，您应向相关责任方寻求解决，神牛对此不承担任何责任。因非在保修期或保修范围内的部件、附件或软件导致产品不能正常使用的，不是保修范围内的故障。产品使用过程中正常的脱色、磨损和消耗，不是保修范围内的故障。

## 产品保修和服务支持信息

产品的保修期和服务类型按以下《产品保修信息》执行：

产品类别	选件名称	保修期(月)	保修服务类型
部件	电路板	12	客户送修
其他	光效附件、各类线材、航空箱或 其他包装	无	无保修

神牛产品售后服务电话 0755-29609320-8062

## Warranty

Dear customers, as this warranty card is an important certificate to apply for our maintenance service, please fill in the following form in coordination with the seller and safe-keep it. Thank you!

Product Information	Model	Product Code Number
Customer Information	Name	Contact Number
	Address	
Seller Information	Name	
	Contact Number	
	Address	
	Date of Sale	
Note:		

Note: This form shall be sealed by the seller.

### Applicable Products

Applicable Products The document applies to the products listed on the Product Maintenance Information (see below for further information). Other products or accessories (e.g. promotional items, giveaways and additional accessories attached, etc.) are not included in this warranty scope.

### Warranty Period

The warranty period of products and accessories is implemented according to the relevant Product Maintenance Information. The warranty period is calculated from the day (purchase date) when the product is bought for the first time, and the purchase date is considered as the date registered on the warranty card when buying the product.

### How to Get the Maintenance Service

If maintenance service is needed, you can directly contact the product distributor or authorized service institutions. You can also contact the Godox after-sale service call and we will offer you service. When applying for maintenance service, you should provide valid warranty card. If you cannot provide valid warranty card, we may offer you maintenance service once confirmed that the product or accessory is involved in the maintenance scope, but that shall not be considered as our obligation.

### Inapplicable Cases

The guarantee and service offered by this document are not applicable in the following cases: ① **The product or accessory has expired its warranty period;** ② **Breakage or damage caused by inappropriate usage, maintenance or preservation, such as improper packing, improper usage, improper plugging in/out external equipment, falling off or squeezing by external force, contacting or exposing to the improper temperature, solvent, acid, base, flooding and damp environments, etc;** ③ **Breakage or damage caused by non-authorized institution or staff in the process of installation, maintenance, alternation, addition and detachment;** ④ **The original identifying information of product or accessory is modified, alternated, or removed;** ⑤ **No valid warranty card;** ⑥ **Breakage or damage caused by using illegally authorized, nonstandard or non-public released software;** ⑦ **Breakage or damage caused by force majeure or accident;** ⑧ **Breakage or damage that could not be attributed to the product itself.** Once met these situations above, you should seek solutions from the related responsible parties and Godox assumes no responsibility. The damage caused by parts, accessories and software that beyond the warranty period or scope is not included in our maintenance scope. The normal discoloration, abrasion and consumption are not the breakage within the maintenance scope.

## Maintenance and Service Support Information

The warranty period and service types of products are implemented according to the following Product Maintenance Information:

ProductType	Name	Maintenance Period(month)	Warranty Service Type
Parts with electrical properties	Circuit board	12	Customer sends the product to designated site
Other Items	Optical accessories, cables, flight case or other packages, etc.	No	Without warranty



Wechat  
Official Account  
神牛微信公众号

### 深圳市神牛摄影器材有限公司

地址：深圳市宝安区福海街道塘尾社区耀川工业区厂房2栋

电话：0755-29609320(8062) 传真：0755-25723423 邮箱：godox@godox.com

### GODOX Photo Equipment Co., Ltd.

Add.: Building 2, Yaochuan Industrial Zone, Tangwei Community, Fuhai Street, Bao'an District,  
Shenzhen 518103, China Tel: +86-755-29609320(8062) Fax: +86-755-25723423  
E-mail: godox@godox.com

[www.godox.com](http://www.godox.com)

Made in China | 705-RS10R0-01

