

Godox

多彩LED氛围灯
LED Webcasting Ambient Light

CL10

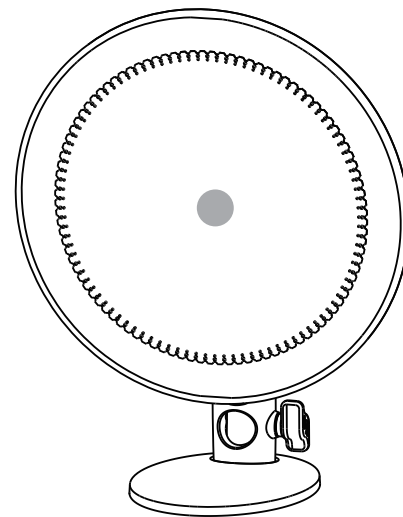

深圳市神牛摄影器材有限公司

地址: 深圳市宝安区福海街道塘尾社区耀川工业区厂房2栋
电话: 0755-29609320(8062) 传真: 0755-25723423 邮箱: godox@godox.com

GODOX Photo Equipment Co., Ltd.

Add: Building 2, Yaochuan Industrial Zone, Tangwei Community, Fuhai Street, Bao'an District,
Shenzhen, China Tel: +86-755-29609320(8062) Fax: +86-755-25723423 E-mail: godox@godox.com

godox.com

Made in China



使用手册
Instruction Manual

前言

感谢您购买神牛产品！

多彩LED氛围灯CL10是一款带有红、绿、蓝、白、橙、黄、绿、紫等彩色光的RGB LED灯，可用无线遥控器或APP调节亮度、色相和14类39种光效模式，也可用作小型摄影棚内创意摄影、采访的背景灯或娱乐主播直播时的氛围灯，营造炫彩光效。

主要特点：

- 一灯多用，随心切换LED多种彩色光和39种情景光效模式
- 通过标配无线遥控器或手机APP，自由调节色彩、亮度等功能
- 跟随音乐跳动并变换颜色，营造多彩氛围
- 时尚小巧，光效柔和，打造各类创意灯光造型

警告

- △ 请保持干燥：请勿用湿手接触产品，亦不可将产品浸入水中或暴露于雨中。
- △ 请勿私自拆卸产品，如产品出现故障须由本公司或授权的维修人员进行检查维修。
- △ 请勿让儿童接触本产品。
- △ 本产品不能防水，在雨天及潮湿环境下请注意防水。
- △ 请勿放置在超过40摄氏度的高温环境中。
- △ 请勿在化学品、可燃性气体或其他特殊物质附近使用摄影灯，在这些场合下，请注意相关警告标识。

部件名称

• 灯体

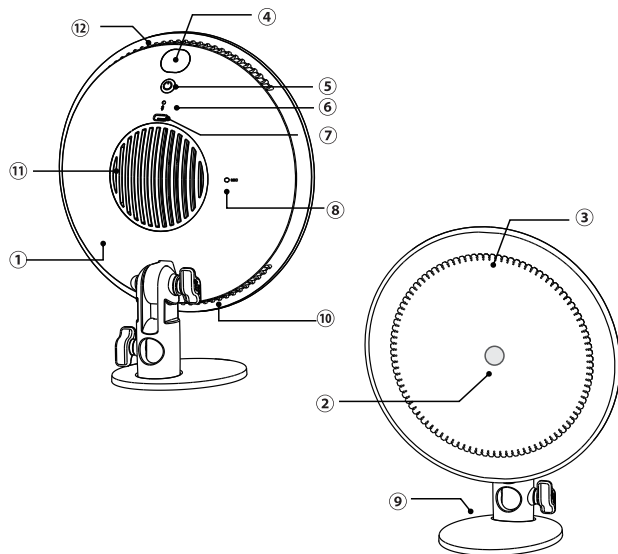

01. 灯体

02. LED灯珠

03. 灯珠镜片

04. 遥控器接收窗

05. 开关按键

06. 指示灯

07. Type-C接口

08. MIC孔

09. 可拆卸底座

10. 进风口

11. 散热口1

12. 散热口2

标配物品

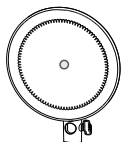

灯体 *1



可拆卸底座 *1



Type-c USB线 *1



RC-R10 无线遥控器 *1



充电器 *1



说明书 *1

接通电源

通过Type-C接口接通充电器，按电源开关。

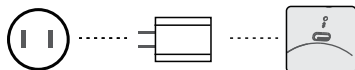

操作说明

• 电源开关按键：

接通电源后，电源指示灯显示红色，短按氛围灯上的电源开关键，可实现氛围灯开机或关闭。

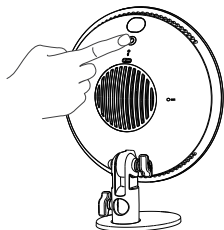

遥控器无线控制

LED氛围灯CL10具备无线遥控功能，可使用遥控器RC-R10控制LED灯亮度大小，开关机，色彩切换，与各光效的设置。

* 亮度-、亮度+、关灯OFF、开灯ON

R 红光、红橙光、黄橙光、浅橙光

G 绿光、青绿光、黄绿光、黄光

B 蓝光、靛色光、青蓝光、浅蓝光

W 白光、深青光、洋紫光、桃粉光

紫光、紫红光、洋红光、紫粉光

色相-、色相+、饱和度-、饱和度+

彩光循环、闪光灯、频率档位-、频率档位+

激光彩灯、雷闪电、坏灯泡、电视机

SOS：蜡烛、火、烟花、SOS

警车、救护车、消防车、音乐模式

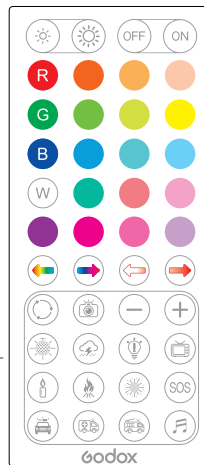

1. 按遥控器上的OFF、ON按键实现RGB灯关灯、开灯功能。
2. **亮度调节**：按遥控器上的亮度-或亮度+键可进行调节(0~100%)，短按一次5个单元值，长按可0~100%快速调节。
3. **静态彩色光**：第二排~第六排为静态彩色光按键，也可用色相-或色相+键调0~360°不同颜色，可根据需求选择。
4. **色相调节**：色相范围0~360°，短按色相-或色相+键可调节10个单元值，长按可0~360°快速调节。
5. **饱和度调节**：饱和度范围0~100%，短按饱和度-或饱和度+键可调节10个单元值，长按可0~100%快速调节。

产品参数

LED灯	CL10
供电	USB供电(5V/2A)
LED灯功率	10W
RGB色彩	0~360°
100%最大流明(LUX)	≈1100(绿光)
照射角度	120°
色相范围	0~360°
饱和度范围	0~100%
无线控制方式	无线遥控器/手机APP
遥控器控制距离	15米
光效模式	共39种场景模式
工作环境温度	-10°~40℃
产品尺寸	192*192*65mm
重量	270g

* 设计和规格如有变更，恕不另行通知。

本设备包含型号核准代码为: CMIIT ID:2020DP13510, 为该产品的无线电发射模块。

6. 情景光效模式有14类共39种，可选择场景后按频率-、频率+键进行调节示：

序号	显示	场景	显示I	显示II	显示III
1		闪光灯	闪光	发布会	狗仔队
2		雷闪电	间歇	频繁	持续
3		坏灯泡	间歇	频繁	持续
4		电视机	慢速	中速	快速
5		彩光循环	慢速	中速	快速
6		激光彩灯	生日会	KTV	迪斯科
7		蜡烛	间歇	频繁	持续
8		火	柴火	篝火	火灾
9		烟花	短暂	连续	演出
10		警车	暴闪	频闪	快闪
11		消防车	暴闪	频闪	快闪
12		救护车	暴闪	频闪	快闪
13		音乐	模式1	模式2	
14		SOS			

注：1.当亮度+、亮度-、色相+、色相-、饱和度-、饱和度+键调到底或到顶时，指示灯闪烁3次。

2.遥控器对准红外接收窗且左右角度偏差不超过15°，距离不超过15米。

蓝牙无线控制

1. 直接扫二维码即可下载“Godox Light”手机APP(安卓和苹果系统都可以使用)。
2. 接通电源开机后打开手机APP进行配对或组网。具体操作请参考手机APP“帮助”手册，里面有详情教程。



维护保养

- 为了防止灰尘的堆积影响到产品的性能，请定时用干净的湿布轻轻擦拭产品外部。
- 1年保修，充电器，USB线等配件不在此保修范围内。
- 对于不规范操作引起的机器故障不在保修范围内。
- 所有维修概由本厂指定可供原厂配件之维修部负责。
- 经发现，擅自检修本品，将取消一年保修期，维修需要收取相关费用。
- 如果本品出现故障或者被水淋湿，在专业人员维修后方可继续使用。
- 如有技术更改，恕不另行通知。

Foreword

Thank you for purchasing this Godox Product!
LED Webcasting Ambient Light CL10 is a RGB light with colorful lights e.g. red, green, blue, white, orange, yellow, green, purple, etc. Adjusted brightness, hue and 39 special effects modes(14 categories) by wireless remote control and smartphone APP, CL10 can be served as background light or interior light for studio shooting, livestream and various of creative shooting.

Features:

- Freely switch LED colorful mode and 39 situational special effects modes
- Easy to adjust colors and light brightness by wireless remote control or smartphone APP
- Blink and change colors with the rhythm of music
- Fashionable, compact and versatile

⚠ Warning

- ⚠ Always keep this product dry. Do not use in rain or in damp conditions.
- ⚠ Do not disassemble. Should repairs become necessary, this product must be sent to an authorized maintenance center.
- ⚠ Keep out of reach of children.
- ⚠ As this product do not have waterproof function, please take measures of waterproof in rainy or damp environment.
- ⚠ As this product may heat up in working, please do not touch.

Name of Body

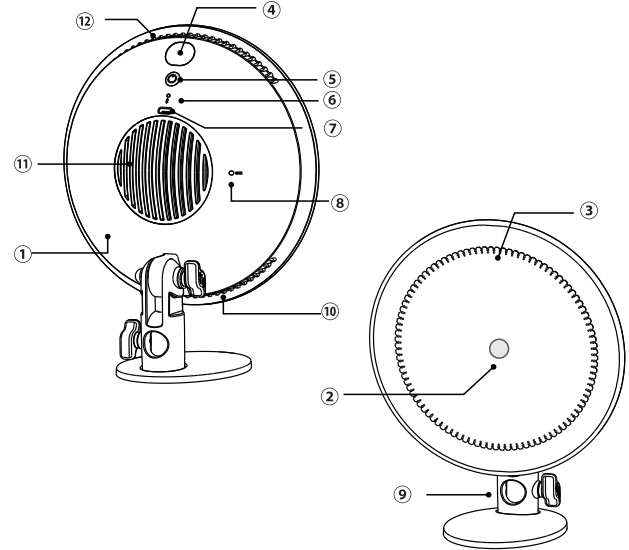

- 01. Light Body
- 02. LED Beads
- 03. Lens of LED Beads
- 04. Remote Control Receive Port
- 05. Power Switch
- 06. Indicator

- 07. Type-C Port
- 08. MIC Hole
- 09. Detachable Holder
- 10. Fan Inlet
- 11. Thermovent 1
- 12. Thermovent 2

What's in the Box

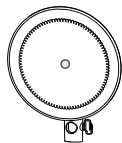

Light Body *1



Detachable Holder *1



Type-C USB Cable *1



RC-R10
Remote Control *1



Charger *1



Instruction Manual *1

Power Supply

Connect the LED light to power source through Type-C port. Press the power switch to turn on the LED light.

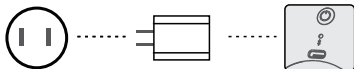

Operation

• Power Switch:

After connecting to the power source, short press the power switch to power on or off the light.

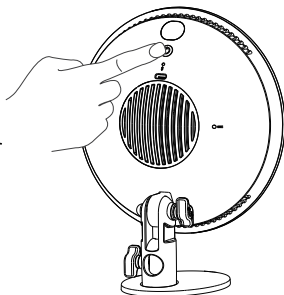

Wireless Control by Remote Control

As the LED Webcasting Ambient Light processes wireless remote control functions, the brightness values, power on or off, color changes and light effects settings can be controlled by RC-R10 remote control.

☀ ☀ OFF ON : brightness -, brightness +, turn off OFF, turn on ON

R R R R : R red, red orange, yellow orange, light orange

G G G G : G green, cyan green, yellow green, yellow

B B B B : B blue, indigo blue, cyan blue, light blue

W W W W : W white, dark cyan, light purple, pink

purple, magenta, carmine, purple pink

hue -, hue +, saturation -, saturation +

RGB recycle, flash, frequency -, frequency +

laser, lightning, broken bulb, TV





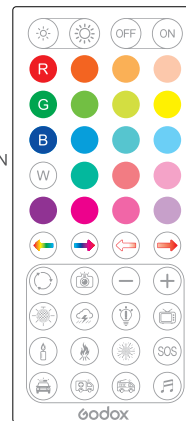

candle, fire, firework, SOS

police car, ambulance, fire truck, music mode



1. Press the OFF or ON button on the remote control to achieve the power off or power on function of LED light.
2. **Brightness adjustment:** press the brightness - or + button on the remote control to adjust the brightness from 0% to 100%. Short press the brightness button once to adjust in 5 values while long pressing the button to achieve quick adjustment from 0% to 100%.
3. **Static color lights:** The buttons from the second row to the sixth row on remote control are static color lights button. You can also select different colors from 0 to 360° by pressing hue - or hue + button.
4. **Hue adjustment:** the range of hue is 0 to 360°. Short press the hue - or hue + button to adjust in 10 values while long pressing the button to achieve quick adjustment from 0 to 360°.
5. **Saturation adjustment:** the range of saturation is 0 to 100%. Short press the saturation - or + button to adjust in 10 values while long pressing the button to achieve quick adjustment from 0% to 100%.

6. There are 39 light effects modes which are divided into 39 kinds. Press the frequency – or + button to adjust after selecting the scene:

No.	Display	Scene	Display I	Display II	Display III
1		Flash	Flash	Press conference	Paparazzi
2		Lightning	Discontinuous	Frequent	Sustainable
3		Broken bulb	Discontinuous	Frequent	Sustainable
4		TV	Slow speed	Medium speed	Quick speed
5		RGB cycle	Slow speed	Medium speed	Quick speed
6		Laser	Birthday party	KTV	Disco
7		Candle	Discontinuous	Frequent	Sustainable
8		Fire	Firewood	Campfire	Fire hazard
9		Firework	Brief	Continuous	Show
10		Police car	Strong flash	Frequent flash	Quick flash
11		Fire truck	Strong flash	Frequent flash	Quick flash
12		Ambulance	Strong flash	Frequent flash	Quick flash
13		Music	Mode 1	Mode 2	
14		SOS			

Note:

1. When the buttons of brightness +, brightness -, hue -, hue +, saturation - and saturation + have hit the bottom, the blue indicator will blink for 3 times.
2. The remote control should aim at the infrared receive window whose angular deviation in left and right are no more than 15° and distance no more than 15m.

Bluetooth Wireless Control

1. Scan the QR code to download the "Godox Light" smartphone APP (can be used on Android and Apple system).
2. After connecting to power supply, open the APP on smartphone to match or create studio.



For more smartphone APP operations, please open the "help" in APP to gain detailed guidance.

Technical Data

Model	CL10
Power Supply	USB Power supply(5V/2A)
LED Light's Power	10W
RGB Color	0 ~ 360°
100% Max. Illumination(LUX)	≈1100 (green light)
Beam Angle	120°
Hue Range	0 ~ 360°
Saturation Range	0 ~ 100%
Wireless Control Modes	Wireless Remote control/ Smartphone APP
Wireless Control Distance	15m
Light Effects Modes	39
Temperature of Working Environment	-10° ~ 40°C
Dimension	192*192*65mm
Weight	270g

* Product design and specifications are subject to change without notice.

Maintenance

This product, except consumables e.g. charger and charger cable, is supported with a one-year warranty.

Avoid sudden impacts and the product should be dedusted regularly.

Maintenance of the flash must be performed by our authorized maintenance department which can provide original accessories.

Unauthorized service will void the warranty.

If the product had failures or was wetted, do not use it until it is repaired by professionals.

Changes made to the specifications or designs may not be reflected in this manual.

Warning

Operating frequency:2402MHz – 2480MHz
Maximum EIRP Power: 3.53dBm

Declaration of Conformity

GODOX Photo Equipment Co.,Ltd. hereby declares that this equipment are in compliance with the essential requirements and other relevant provisions of Directive 2014/53/EU. In accordance with Article 10(2) and Article 10(10), this product is allowed to be used in all EU member states.For more information of DoC, Please click this web link:

https://www.godox.com/DOC/Godox_CL10_DOC.pdf

The device complies with RF specifications when the device used at 0mm from your body.

FCC Statement

This device complies with part 15 of the FCC Rules. Operation is subject to the following two conditions: (1) This device may not cause harmful interference, and (2) this device must accept any interference received, including interference that may cause undesired operation.

Any Changes or modifications not expressly approved by the party responsible for compliance could void the user's authority to operate the equipment.

Note: This equipment has been tested and found to comply with the limits for a Class B digital device, pursuant to part 15 of the FCC Rules. These limits are designed to provide reasonable protection against harmful interference in a residential installation. This equipment generates uses and can radiate radio frequency energy and, if not installed and used in accordance with the instructions, may cause harmful interference to radio communications. However, there is no guarantee that interference will not occur in a particular installation. If this equipment does cause harmful interference to radio or television reception, which can be determined by turning the equipment off and on, the user is encouraged to try to correct the interference by one or more of the following measures:

- Reorient or relocate the receiving antenna.
- Increase the separation between the equipment and receiver.
- Connect the equipment into an outlet on a circuit different from that to which the receiver is connected.
- Consult the dealer or an experienced radio/TV technician for help.