

合格证
QC PASS

Godox

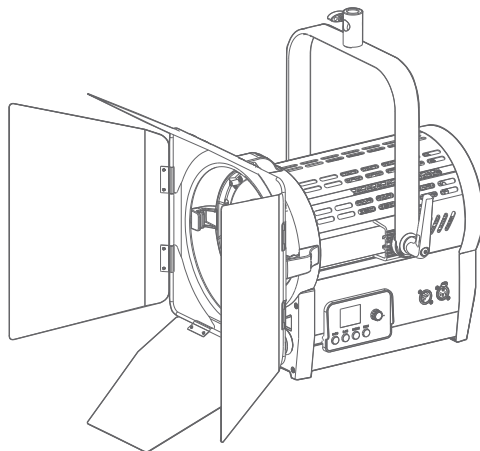

Wechat
Official Account
神牛微信公众号

深圳市神牛摄影器材有限公司

地址: 深圳市宝安区福海街道塘尾社区耀川工业区厂房2栋
电话: 0755-29609320(8062) 传真: 0755-25723423 邮箱: godox@godox.com

GODOX Photo Equipment Co., Ltd.

Add: Building 2, Yaochuan Industrial Zone, Tangwei Community, Fuhai Street, Bao'an District, Shenzhen 518103, China
Tel: +86-755-29609320(8062) Fax: +86-755-25723423 E-mail: godox@godox.com

www.godox.com

Made in China | 705-F7120B-01



F7-120Bi

神牛双色LED菲涅尔灯
GODOX Bi-color LED Fresnel

说明书
Instruction Manual

重要的安全说明及注意事项

首先作为最基本原则：本产品为专业灯光布景设备，应由专业灯光师使用或在专业人士指导下使用。使用时必须始终遵循基本的安全预防措施，具体安全预防措施如下：

1. 使用前必须阅读并理解产品说明书。
2. 专业灯具，禁止儿童使用。当儿童靠近时，家长或监护人必须密切监督，以免儿童因碰撞灯具或私用灯具造成人身伤害。
3. 本灯具并非普通照明灯具，不可用于普通照明，任何有过眼部损伤或眼部敏感的人群均应避免使用本灯具。
4. 灯具点亮时，必须小心使用，禁止接触高温部件，如LED灯珠，以免造成灼伤。
5. 灯具点亮时，任何情况下均禁止直视灯珠。应该在专业灯光师指导下使用强光，任何情况下避免长时间处于强光环境，如引起眼睛不适，请及时关闭灯具，暂停使用，请及时就医。
6. 倘灯珠损坏或因热变形，应停止使用，并及时联系制造商、服务代理商或合格的维修人员更换灯珠，以免发生意外。
7. 本产品仅适用于 **-20~50°C** 工作环境温度及正常湿度环境下使用。
8. 请勿使用损坏的设备或设备配件，待专业维修人员检查维修，确认设备正常方可使用。
9. 在使用过程中，如果本产品由于跌落、受到挤压或遭受强烈冲击而造成外壳破裂的，请勿继续使用，以免因接触到内部电子元件而受到电击伤害。
10. 如需要延长线，请使用额定电流>该设备额定电流的延长线。如延长线额定电流小于该设备，可能导致过热。
11. 部分产品电源线较长，请合理放置电源线，使其处于安全位置。避免电源线接触过热物体表面、避免放置不当导致拉扯损坏或绊倒现场人员。请使用本厂原装电源线，如使用非本厂电源线导致产品损坏，概不在本厂维修范围内。
12. 在清洁和维修之前，请务必从电源插座上拔下该设备插头。不使用时，禁止拉扯电源线以将设备插头从电源插座中拔出。正常断电，应是用手抓住该设备插头两端，将插头从电源插座中拔出。此设备需连接到接地插座中。
13. 本设备没有防水性能，请让设备保持干燥，请勿将本设备浸入水中或其他液体中。设备需安装在干燥且通风处，避免在雨天、潮湿、多尘或过热环境下使用。请勿将任何物体置于灯具上或使液体流入灯具内部，以免发生意外。
14. 请勿私自拆卸产品，如产品出现故障，须由本公司或授权的维修人员进行检查维修。
15. 存放本设备之前，请确保设备已完全冷却。存放时，将电源线从设备上拔出。设备应放置于设备便携包内或通风干燥处。
16. 请勿将设备放置在酒精、汽油等易燃易挥发的溶剂附近。
17. 本厂不推荐的产品附件，请勿使用，以免导致火灾、触电或人身伤害。
18. 清洁本设备时，请勿用湿布擦拭，请用干布、软布擦拭设备污垢。
19. 设备使用前，请注意将保护罩取下。
20. 本产品已通过ROHS, CE认证，请参考相关国家标准使用和操作。



21. 安全说明依据本厂严格测试制定，设备设计和规格如有变更，恕不另行通知。客户可以上神牛官网查看最新的电子版说明，了解产品最新资讯。
22. 部分产品内置锂电池。此类产品请使用专用的充电器进行充电，并且按正确的操作说明，在规定的电压、温度范围内使用。
23. 部分产品使用电池供电。此类产品请勿使用说明书中未指定的任何电池、电源或附件。请将电池和其他附件置于儿童及婴幼儿无法触及之处。如果儿童或婴幼儿吞下电池或附件，请立即就医。如果电池漏液、变色、变形、冒烟或发出异味，请立即将其取出。在取出过程中请小心，以免烫伤。如果继续使用，可能会引起火灾、触电或皮肤烫伤。请勿使用任何变形或改造过的电池。请勿拆卸或改造本产品或电池。请勿加热电池或焊接电池。请勿让电池与火或水接触。请勿让电池受到强烈的外力撞击。请勿将电池的正负极错误插入，或将新旧电池或不同类型的电池混合使用。
24. 一年保修期，消耗品电池、适配器、电源线等配件不在此保修范围内。
25. 经发现，擅自检修设备，将取消一年保修期，维修需要收取相关费用。
26. 对于不规范操作引起的机器故障不在保修范围内。

前言

感谢您购买神牛产品！

神牛双色 LED 菲涅尔灯 F7-120Bi 支持AC供电和灵活调焦（15°-60°），拥有无极调光、色温可调（3200K-5600K）、蓝牙控制 / DMX512 控制等诸多特性；适用于多功能厅、媒体中心、电视台、校园电视台、摄影棚等场所。

警告

-  请勿私自拆卸产品，如产品出现故障须由本公司或授权的维修人员进行检查维修。
-  本产品不能防水，在雨天及潮湿的环境下注意防水。
-  在不使用时，请断开电源。

本设备包含型号核准代码为：CMIIT ID:23J44811A002,为该产品的无线电发射模块。

部件名称

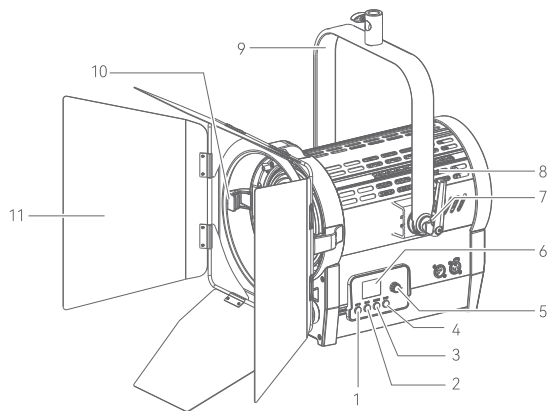

1. INFO 按键
2. 蓝牙按键
3. MODE 按键
4. DMX 按键
5. 调节旋钮
6. 显示屏
7. 支架按钮
8. 散热孔
9. U 型架
10. 挡板夹槽
11. 四叶挡板

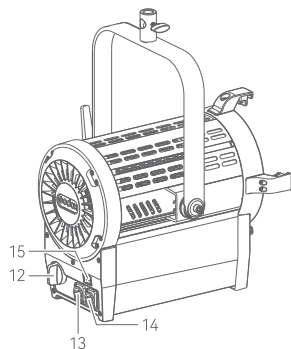

F7-120Bi K1物料清单(适合吊装)

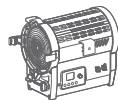

灯体
x 1

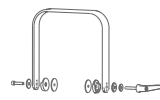

U 型架
x 1

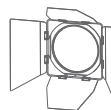

4 叶遮菲
x 1



AC电源
输入插头
x 1



AC电源
输出插头
x 1



DMX IN
三芯卡侏头接口
x 1



DMX OUT
三芯卡侏头接口
x 1



灯具吊柄
x 1



安全绳
x 1



说明书
x 1

F7-120Bi K2物料清单(适用于三脚架)

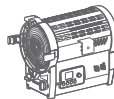

灯体
x 1

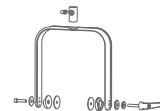

U 型架
x 1

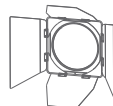

4 叶遮菲
x 1



电源线
x 1



安全绳
x 1



说明书
x 1

开机/关机

接通电源后，拨动开关按钮实现开机/关机。

亮度调节

短按 MODE 按钮进入灯光模式界面，短按调节旋钮至亮度值选项，旋转调节旋钮即可进行亮度调节，显示方式：0-255/0%-100%。

注：进入界面后，短按 MODE 按钮可切换亮度显示方式，如0-255/0%-100%。

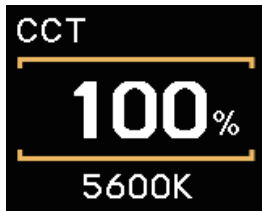

色温调节

短按 MODE 按钮进入灯光模式界面，短按调节旋钮至色温选项，旋转调节旋钮即可进行色温调节，调节范围：3200K-5600K。

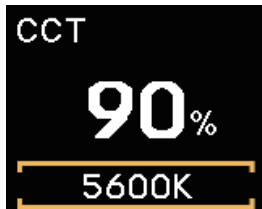

蓝牙设置

短按蓝牙按钮进入无线设置界面，短按调节旋钮可选 BLE(蓝牙开关)/ RESET(蓝牙重置)选项。选好选项后，旋转调节旋钮可调节相关参数。

蓝牙开关：可选 ON(开启)/ OFF(关闭)。

蓝牙重置：可选 YES(是)/ NO(否)。选中

“YES”后，短按调节旋钮即可进行蓝牙重置。

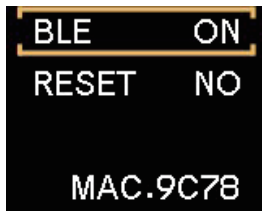

“Godox light”App

扫描下面二维码即可下载“Godox Light”手机APP（安卓和苹果系统都可以使用）。

注：首个移动设备（手机或平板电脑）可直接使用APP操控灯体。更换其他移动设备时，灯体需进行蓝牙重置方可正常使用APP。APP需升级至V3.0以上版本。



DMX 设置

短按 DMX 按钮进入 DMX 设置界面。旋转调节旋钮选择 DMX 地址（1-512）。

DMX 连接展示

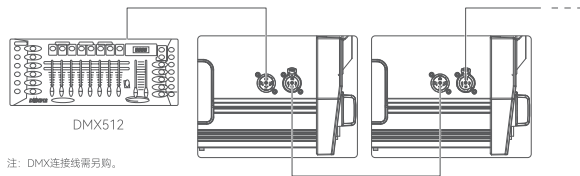

注：DMX连接需另购。

DMX 实用表

模式名称	通道	功能	DMX 数值	参数
CCT 8bit	1	亮度	0 - 255	0% - 100%
	2	色温	0 - 255	3200K - 5600K

灯具信息

短按 INFO 按键进入灯具信息界面，查看当前灯具固件版本号。



照度数据 (F7-120Bi)

聚光					
色温	照度单位	1m	2m	3m	5m
3200K	lux	≈35700	≈10600	≈5100	≈1880
	fc	≈3310	≈988	≈473	≈174
4300K	lux	≈41700	≈12400	≈5950	≈2210
	fc	≈3870	≈1150	≈552	≈205
5600K	lux	≈43100	≈12900	≈6140	≈2280
	fc	≈4000	≈1190	≈570	≈210

泛光					
色温	照度单位	1m	2m	3m	5m
3200K	lux	≈10300	≈2750	≈1280	≈468
	fc	≈955	≈256	≈119	≈43.5
4300K	lux	≈12000	≈3220	≈1500	≈548
	fc	≈1110	≈299	≈139	≈51
5600K	lux	≈12400	≈3320	≈1550	≈563
	fc	≈1150	≈309	≈144	≈52.3

以上测试皆在灯体100%亮度下进行。

规格参数

型号	F7-120Bi
输入功率	≈120W
供电	AC 100~240V 50/60Hz
色温	3200K-5600K
CRI	平均≥96
TLCI	平均≥97
控制方式	蓝牙控制/ DMX512 控制/灯体面板控制
蓝牙控制距离	最远30米
工作温度	-20~50℃
尺寸 (U 型架展开状态)	509mm*324mm*381mm 20"*12.8"*15"
净重 ≈	7.63kg

规格和参数如有变更，恕不另行通知。

Safety Instructions and Attentions

First of all, as the most basic principle: This product is a professional lighting set equipment and should be used by professional lighting engineers or under the guidance of professionals. Basic safety attentions must always be followed during use, as follows:

1. Before use, please read and understand these instructions and attentions.
2. Professional lighting is prohibited for children. When children are near, parents or accompanying persons must supervise closely to prevent children from personal injury due to collision with lamps or private use of lamps.
3. This lighting product is not ordinary lighting product and cannot be used for general lighting. Anyone who has suffered eye damage or has sensitive eyes should avoid using this product.
4. When the lamp is on, it must be used with care. Do not touch high-temperature parts, such as LED lamp beads, to avoid burns.
5. When the lamp is on, it is forbidden to look directly at the lamp beads under any circumstances. Strong light should be used under the guidance of professional lighting engineers. Avoid prolonged exposure to strong light under any circumstances. If eye discomfort, please turn off the lamp in time, suspend use, and see a doctor immediately.
6. If the lamp bead is damaged or deformed by heat, stop using this equipment, and contact the manufacturer, service agent or qualified maintenance personnel to replace the lamp bead in time to avoid accidents.
7. This product is only suitable for use in **-20°C to 50°C** operating environment and normal humidity environment.
8. Do not use damaged equipment or accessories, and wait for professional maintenance personnel to check and repair to confirm being normal before use.
9. During using, if the casing of this product is broken due to being dropped, squeezed or subjected to strong impact, please do not use it, so as to avoid electric shock injury due to contact with internal electronic components.
10. If an extension cord is required, please use an extension cord with a current rating greater than or equal to that of the equipment. If an extension cord is rated less than the equipment, overheating may result.
11. Some products have long power cords, please place the power cords properly and keep them in a safe place. Avoid contacting the power cord with overheating surfaces, avoid improper placement that could cause pulling damage, or trip on-site personnel. Please use the certified power cord from the original manufacturer. If the product is damaged by using a non-certified power cord, it will not be repaired by our factory.
12. Be sure to unplug equipment from the power outlet before cleaning and repairing. When not in use, do not pull the power cord to unplug the equipment. For normal power-off, please hold both ends of the plug of the equipment with your hands and pull the plug out of power outlet. This equipment needs to be connected to a grounded outlet.
13. This equipment is not waterproof, please keep it dry and do not immerse it in water or other liquids. The equipment should be installed in a dry and ventilated place, and avoid using it in rainy, humid, dusty or overheated environments. Do not place any objects on the lamp or let liquid flow into the lamp to avoid accidents.
14. Do not disassemble the product without permission. If the product fails, it must be checked and repaired by authorized maintenance personnel.
15. Before storing, make sure that the equipment has cooled down completely. For storage, unplug the power cord from the equipment. The equipment should be placed in the carrying case or in a ventilated dry place.
16. Do not place equipment near flammable and volatile solvents such as alcohol and gasoline.
17. Do not use accessories that are not recommended by our factory to avoid fire, electric shock or personal injury.
18. When cleaning, do not wipe it with a damp cloth, please use a dry cloth or a soft cloth to wipe the dirt of the equipment.
19. Please take off the protective cover before using.
20. This product complies with ROHS and CE certification, please refer to the relevant national standards for use and operation.
21. The safety instructions are formulated according to the strict testing of the factory, and the design and specifications of the equipment are subject to change without prior notice. For latest product information, please check the GODOX website and view latest electronic instruction.
22. Some products have built-in lithium batteries. Please use specified chargers, and use them within a proper range of the specified voltage and temperature according to the correct operating instructions.
23. Some products are battery powered. Do not use any batteries, power sources or accessories not specified in the instructions for such products. Keep batteries and other accessories out of the reach of children and infants. In the instance that a child or infant swallows a battery or accessory, immediate emergency medical attention is required. If the battery leaks, becomes discolored, deformed, emits smoke, or emits an abnormal odor, remove it immediately. Be careful during removal to avoid burns. Continued use could result in fire, electric shock, or burns. Do not use any deformed or modified batteries. Do not disassemble or modify this

product or battery. Do not heat or solder the battery. Keep the battery away from fire or water. Do not incorrectly insert the positive and negative ends of batteries, or mix old and new batteries or batteries of different types together.



24. One-year warranty period, accessories such as consumable batteries, adapters, power cords, etc. are not covered by this warranty.
25. If it is found that the equipment is repaired without authorization, the one-year warranty period will be cancelled and relevant fees will be charged for maintenance.
26. Machine failures caused by non-standard operation are not covered by the warranty.

Foreword

Thank you for purchasing a Godox product!

The Godox Bi-color LED Fresnel F7-120Bi supports AC power and flexible beam angle adjustment (15°-60°), and comes with various features such as stepless dimming, adjustable color temperature (3200K-5600K), Bluetooth control/DMX512 control, etc. It is suitable for use in multi-purpose halls, media centers, TV stations, campus TV stations, photography studios, and other venues.

Warning

-  Do not disassemble. Should repairs become necessary, this product must be sent to an authorized maintenance center.
-  As this product is not waterproof, do not use in rain or damp conditions.
-  To ensure safety, please disconnect the power when not in use.

Name of Parts

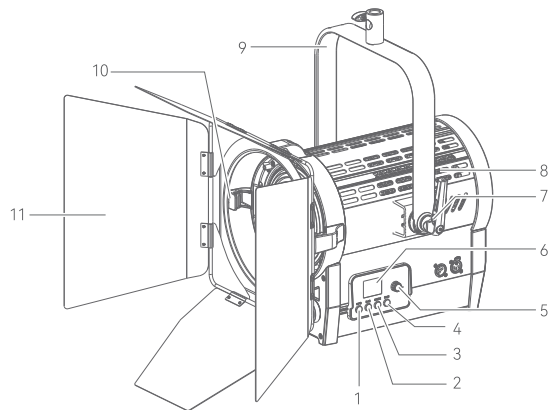

1. INFO Button
2. Bluetooth Button
3. MODE Button
4. DMX Button
5. SET Select Dial
6. Display
7. Bracket Screw
8. Thermovent
9. U-shaped Bracket
10. Barndoor Slot
11. 4-Way Barndoor
12. Focusing Knob
13. AC INPUT Port
14. AC OUTPUT Port
15. Power Switch Button

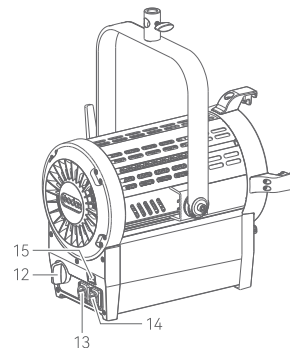

What's Inside F7-120Bi K1(Suitable for Hoisting)

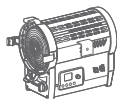

Light Body
x 1

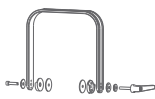

U-Shaped Bracket
x 1

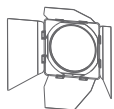

4-Way Barndoor
x 1



AC Power
Input Plug
x 1



AC Power
Output Plug
x 1



DMX IN
XLR Port
x 1



DMX OUT
XLR Port
x 1



Lamp Hanger
x 1



Safety Cable
x 1



Instruction Manual
x 1

What's Inside F7-120Bi K2(Suitable for Tripods)

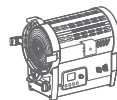

Light Body
x 1

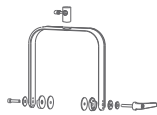

U-Shaped Bracket
x 1

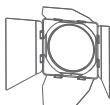

4-Way Barndoor
x 1



Power Cord
x 1



Safety Cable
x 1



Instruction Manual
x 1

Power Switch

Toggle the power switch button to turn on the unit after you connect the AC adapter to the power supply.

Brightness Adjustment

Short press the MODE button to enter the brightness adjustment interface, turn the select dial to adjust the brightness. The display shows the range from 0-255/0%-100%.

Note: After entering the interface, you can short press the MODE button to switch the brightness display mode. The display shows the range from 0-255/0%-100%.

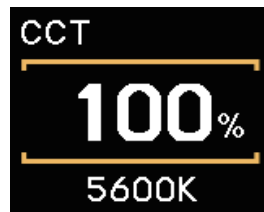

Color Temperature Adjustment

Short press the MODE button briefly to enter the lighting mode interface. Short press the select dial to color temperature option. Turn the select dial to adjust the color temperature. The color temperature can be adjusted within the range of 3200K-5600K.

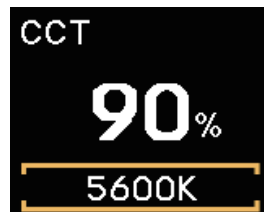

Bluetooth Setting

Short press the Bluetooth button to enter the wireless setting, short press the select dial to select BLE(Bluetooth switch)/RESET(Bluetooth reset), then turn the Select dial to adjust settings or reset.



Bluetooth switch: optional ON/OFF

Bluetooth reset: optional YES/NO. After selecting "YES", you can reset the Bluetooth function by short pressing the select dial.

"Godox Light" App

Scan the QR code to download "Godox Light" app (both Android and iOS systems are available).

Note: The app can be used directly on the firstly installed device (smartphone or tablet). When changing to other mobile device, the light shall be reset before the normal use of the app. The app should be V3.0 or above.



DMX Setting

Short press DMX button to enter DMX setting interface. Turn the select dial to select address (1-512).

Connect to DMX Controller

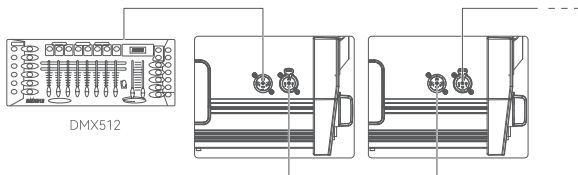

Note: DMX connection cable needs to be purchased separately.

DMX Practical Table

Mode	DMX Channel	Function	DMX Value	Parameters
CCT 8bit	1	Brightness	0 – 255	0% – 100%
	2	CCT	0 – 255	3200K – 5600K

Fixture Info

Short press the INFO Button to enter fixture info setting interface to check firmware version.



Photometric Data (F7-120Bi)

Spot					
CCT	Unit	1m	2m	3m	5m
3200K	lux	≈35700	≈10600	≈5100	≈1880
	fc	≈3310	≈988	≈473	≈174
4300K	lux	≈41700	≈12400	≈5950	≈2210
	fc	≈3870	≈1150	≈552	≈205
5600K	lux	≈43100	≈12900	≈6140	≈2280
	fc	≈4000	≈1190	≈570	≈210

Flood					
CCT	Unit	1m	2m	3m	5m
3200K	lux	≈10300	≈2750	≈1280	≈468
	fc	≈955	≈256	≈119	≈43.5
4300K	lux	≈12000	≈3220	≈1500	≈548
	fc	≈1110	≈299	≈139	≈51
5600K	lux	≈12400	≈3320	≈1550	≈563
	fc	≈1150	≈309	≈144	≈52.3

Note: All of the above tests are based on 100% brightness.

Technical Data

Model	F7-120Bi
Input Power	≈120W
Power Supply	AC 100~240V 50/60Hz
CCT	3200K~5600K
CRI	Average≥96
TLCI	Average≥97
Controlling Methods	Bluetooth control/DMX512 control/ Light body panel control
Bluetooth Controlling Distance	Max. 30m
Working Environment Temperature	-20~50°C
Dimension(Unfolded state of U-shaped bracket)	509mm*324mm*381mm 20"*12.8"*15"
Netweight ≈	7.63kg

Specifications and data may subject to changes without notice.

FCC Statement

This device complies with part 15 of the FCC Rules. Operation is subject to the following two conditions:

- (1) This device may not cause harmful interference, and
- (2) this device must accept any interference received, including interference that may cause undesired operation.

Any Changes or modifications not expressly approved by the party responsible for compliance could void the user's authority to operate the equipment.

Note: This equipment has been tested and found to comply with the limits for a Class B digital device, pursuant to part 15 of the FCC Rules. These limits are designed to provide reasonable protection against harmful interference in a residential installation. This equipment generates uses and can radiate radio frequency energy and, if not installed and used in accordance with the instructions, may cause harmful interference to radio communications. However, there is no guarantee that interference will not occur in a particular installation. If this equipment does cause harmful interference to radio or television reception, which can be determined by turning the equipment off and on, the user is encouraged to try to correct the interference by one or more of the following measures:

- Reorient or relocate the receiving antenna.
- Increase the separation between the equipment and receiver.
- Connect the equipment into an outlet on a circuit different from that to which the receiver is connected.
- Consult the dealer or an experienced radio/TV technician for help.

The device has been evaluated to meet general RF exposure requirement. The device can be used in portable exposure condition without restriction.

Warning

Operating frequency: 2402MHz – 2480MHz (BT)
Maximum EIRP Power: 9.44dBm

Declaration of Conformity

GODOX Photo Equipment Co.,Ltd. hereby declares that this equipment are in compliance with the essential requirements and other relevant provisions of Directive 2014/53/EU. In accordance with Article 10(2) and Article 10(10), this product is allowed to be used in all EU member states. For more information of DoC, Please click this web link:

<https://www.godox.com/eu-declaration-of-conformity/>

The device complies with RF specifications when the device used at 0mm from your body.

产品保修

尊敬的用户, 本保修卡是申请保修服务的重要凭证, 请您配合销售商填写并妥善保管, 谢谢!

产品信息	型号	产品条码
用户信息	姓名	联系电话
	通信地址	
销售商信息	名称	
	联系电话	
	通信地址	
	销售日期	
备注		

注: 此表应由销售商盖章确认。

产品信息

本文件适用于相关《产品保修信息》(见后面说明)所列产品, 其他非属此范围的产品或部件(如促销品、赠品及其他出厂后附加的部件等)不在此保修承诺内。

保修期

产品及部件的相应保修期按相关的《产品保修信息》执行。保修期自产品首次购买日起算, 购买日以购买产品时保修卡登记日期为准。

如何获得保修服务

您可直接与产品销售商或授权服务机构联系, 也可拨打神牛产品售后服务电话, 与我们联系, 由我们的服务人员为您安排服务。申请保修时, 您应提供有效的保修卡作为保修凭证, 方可获得保修。如您不能提供有效的保修卡, 则在我们确认产品或部件属于保修范围的情况下, 也可以为您提供保修, 但这不作为我们的义务。

不适用保修的情况

如产品存在下列情况, 本文件项下的保证和服务将不适用: ①产品或部件超过相应保修期; ②错误或不适当使用、维护或 保管导致的故障或损坏, 如: 不当搬运; 非按产品合理预期用途使用; 不当插拔外接设备; 跌落或外力挤压; 接触或暴露于不当温度、溶剂、酸碱、水浸或潮湿环境; ③由非神牛授权机构或人员安装、修理、更改、添加或拆卸造成的故障或损坏; ④产品或部件原有识别信息被修改变更或删除; ⑤无有效保修卡; ⑥使用非合法授权、非标准或非公开发行的软件造成的故障或损坏; ⑦因不可抗力或意外事件造成的故障或损坏; ⑧其他非因产品本身质量问题导致的故障或损坏。遇上述情况, 您应向相关责任方寻求解决, 神牛对此不承担任何责任。因非在保修期或保修范围内的部件、附件或软件导致产品不能正常使用的, 不是保修范围内的故障。产品使用过程中正常的脱色, 磨损和消耗, 不是保修范围内的故障。

产品保修和服务支持信息

产品的保修期和服务类型按以下《产品保修信息》执行:

产品类别	选件名称	保修期(月)	保修服务类型
部件	电路板	12	客户送修
	电池	3	客户送修
	充电器等带电性能的部件。	12	客户送修
其他	如外壳、保护罩、锁紧装置、包装等。	无	无保修

神牛产品售后服务电话 0755-29609320-8062

Warranty

Dear customers, as this warranty card is an important certificate to apply for our maintenance service, please fill in the following form in coordination with the seller and safe-keep it. Thank you!

Product Information	Model	Product Code Number
Customer Information	Name	Contact Number
	Address	
Seller Information	Name	
	Contact Number	
	Address	
	Date of Sale	
Note		

Note: This form shall be sealed by the seller.

Applicable Products

The document applies to the products listed on the Product Maintenance Information (see below for further information). Other products or accessories (e.g. promotional items, giveaways and additional accessories attached, etc.) are not included in this warranty scope.

Warranty Period

The warranty period of products and accessories is implemented according to the relevant Product Maintenance Information. The warranty period is calculated from the day (purchase date) when the product is bought for the first time, and the purchase date is considered as the date registered on the warranty card when buying the product.

How to Get the Maintenance Service

If maintenance service is needed, you can directly contact the product distributor or authorized service institutions. You can also contact the Godox after-sale service call and we will offer you service. When applying for maintenance service, you should provide valid warranty card. If you cannot provide valid warranty card, we may offer you maintenance service once confirmed that the product or accessory is involved in the maintenance scope, but that shall not be considered as our obligation.

Inapplicable Cases

The guarantee and service offered by this document are not applicable in the following cases: ①

① The product or accessory has expired its warranty period; ② **Breakage or damage caused by inappropriate usage, maintenance or preservation, such as improper packing, improper usage, improper plugging in/out external equipment, falling off or squeezing by external force, contacting or exposing to the improper temperature, solvent, acid, base, flooding and damp environments, etc;** ③ **Breakage or damage caused by non-authorized institution or staff in the process of installation, maintenance, alternation, addition and detachment;** ④ **The original identifying information of product or accessory is modified, alternated, or removed;** ⑤ **No valid warranty card;** ⑥ **Breakage or damage caused by using illegally authorized, nonstandard or non-public released software;** ⑦ **Breakage or damage caused by force majeure or accident;** ⑧ **Breakage or damage that could not be attributed to the product itself.** Once met these situations above, you should seek solutions from the related responsible parties and Godox assumes no responsibility. The damage caused by parts, accessories and software that beyond the warranty period or scope is not included in our maintenance scope. The normal discoloration, abrasion and consumption are not the breakage within the maintenance scope.

Maintenance and Service Support Information

The warranty period and service types of products are implemented according to the following Product Maintenance Information:

Product Type	Name	Maintenance Period(month)	Warranty Service Type
Parts	Circuit board	12	Customer sends the product to designated site
	Battery	3	Customer sends the product to designated site
	Electrical parts e.g.battery charger, etc.	12	Customer sends the product to designated site
Other Items	Lamp body, lamp cover, locking device, package, etc..	No	Without warranty

Godox After-sale Service Call +86-755-29609320(8062)